

**Evin Tech Kft.**

eszköz megnevezése:  
**csúszdás vár hálóval**

**cikkszám: CSVH-02**  
dátum: 2016 04.27.

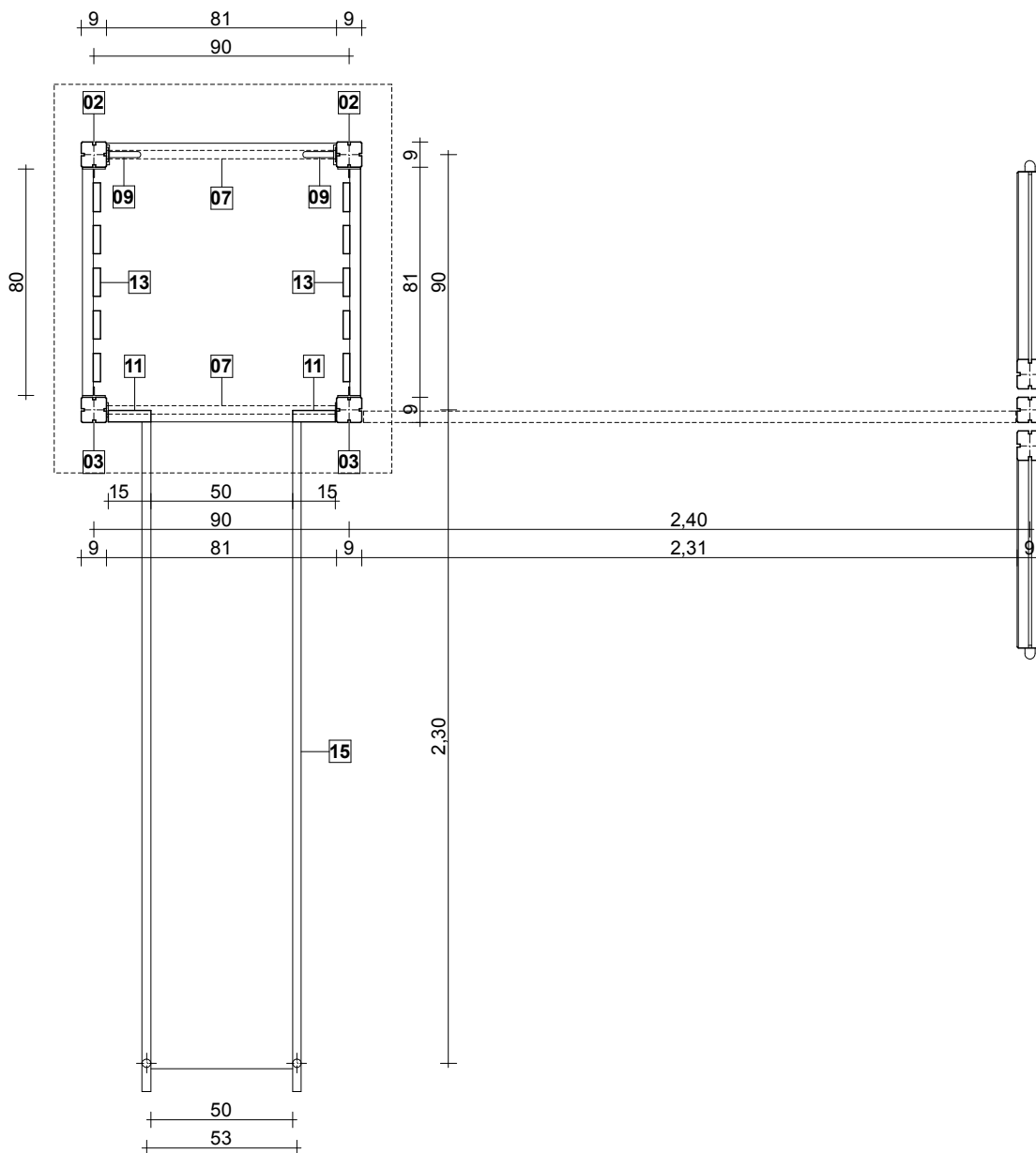

alaprjz / vízszintes metszet +1,25 m /  
m1:25

**alpozási alaprajz  
m1:25**

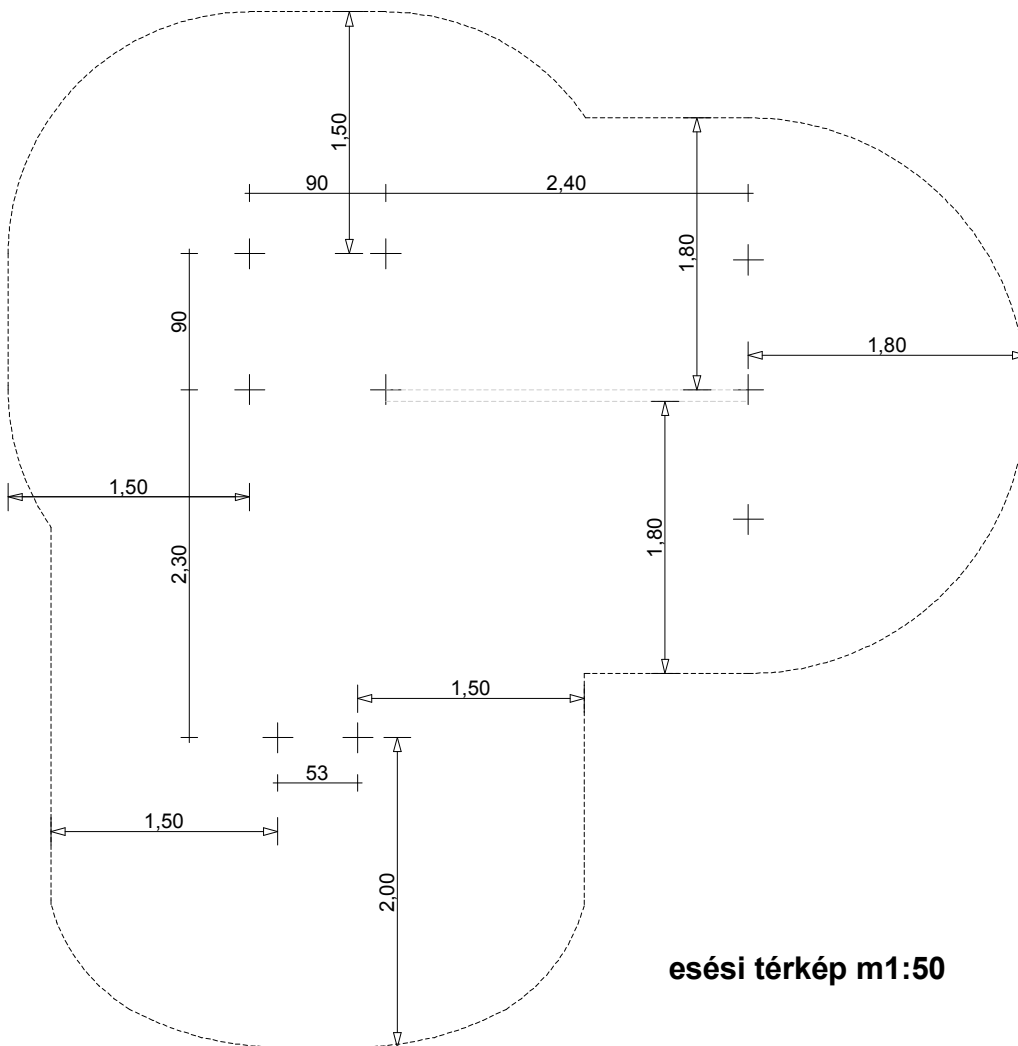
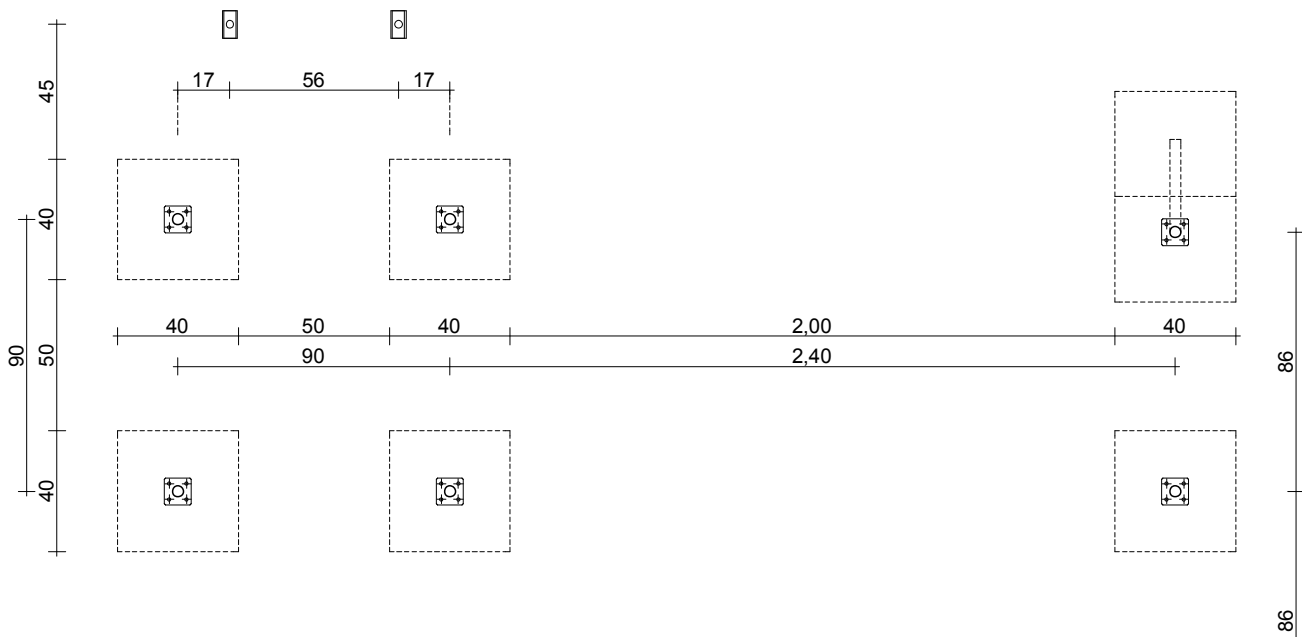

**esési térkép m1:50**

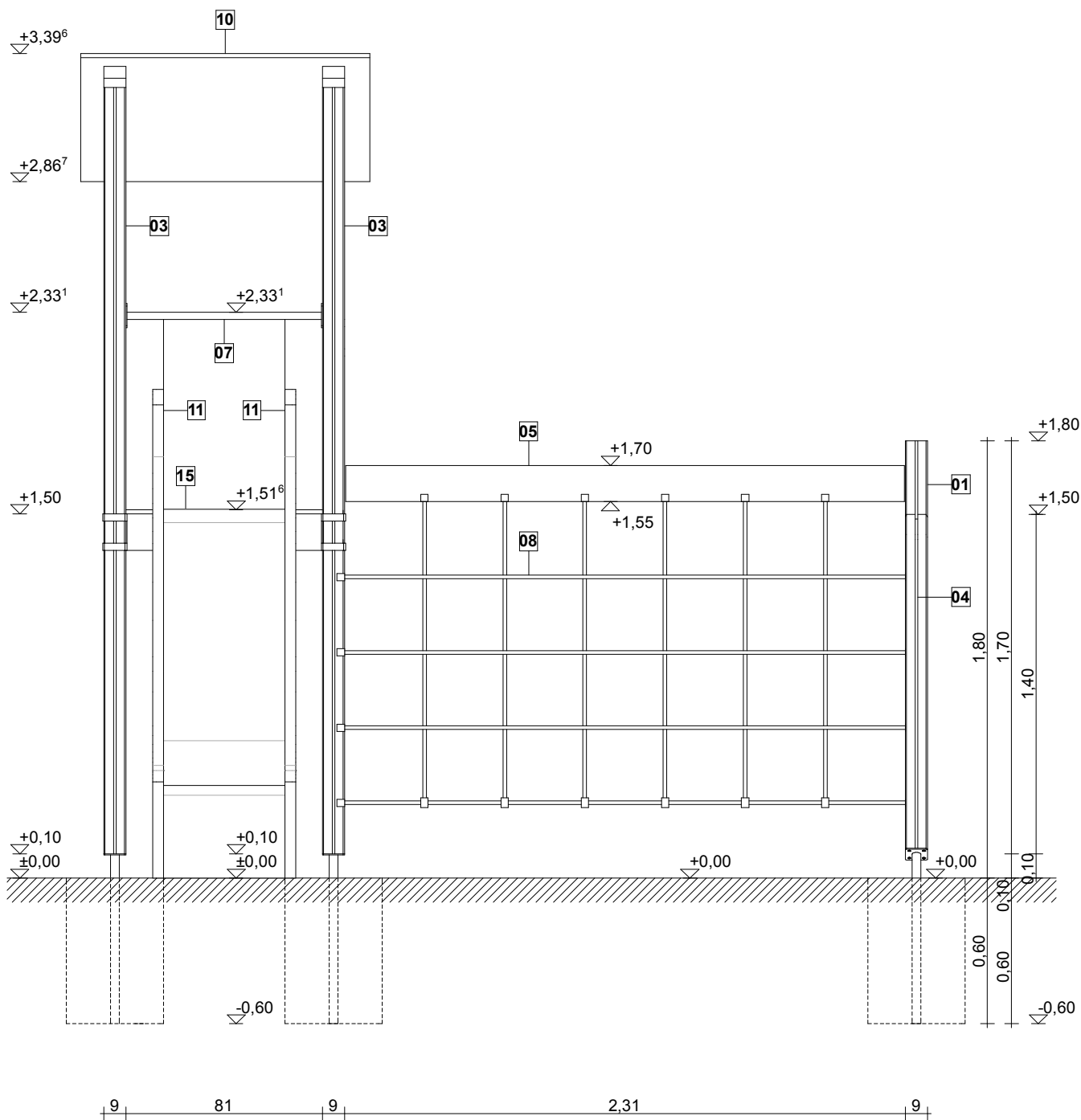

**előlnézet  
m1:25**

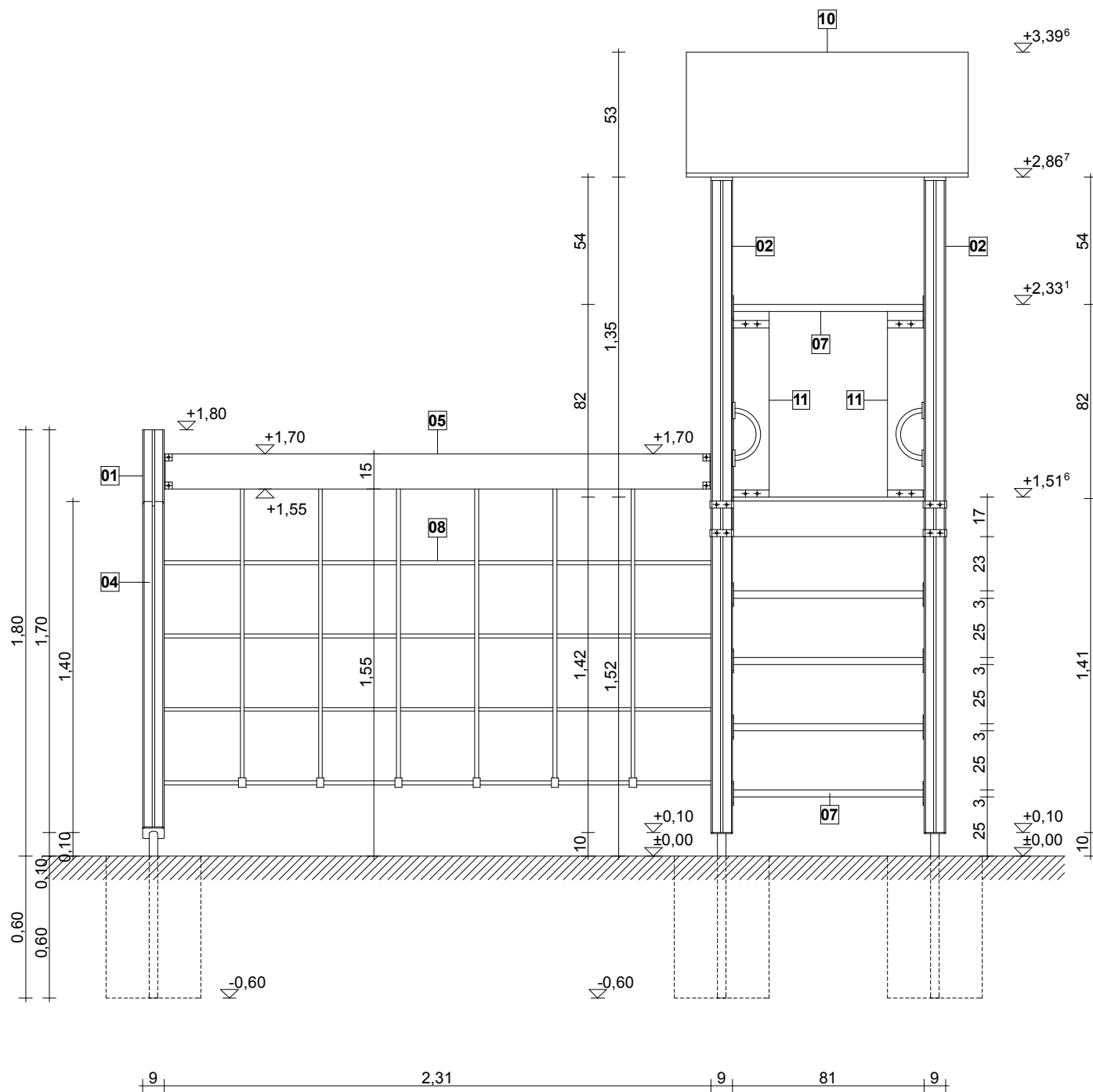

**hátulnézet  
m1:25**

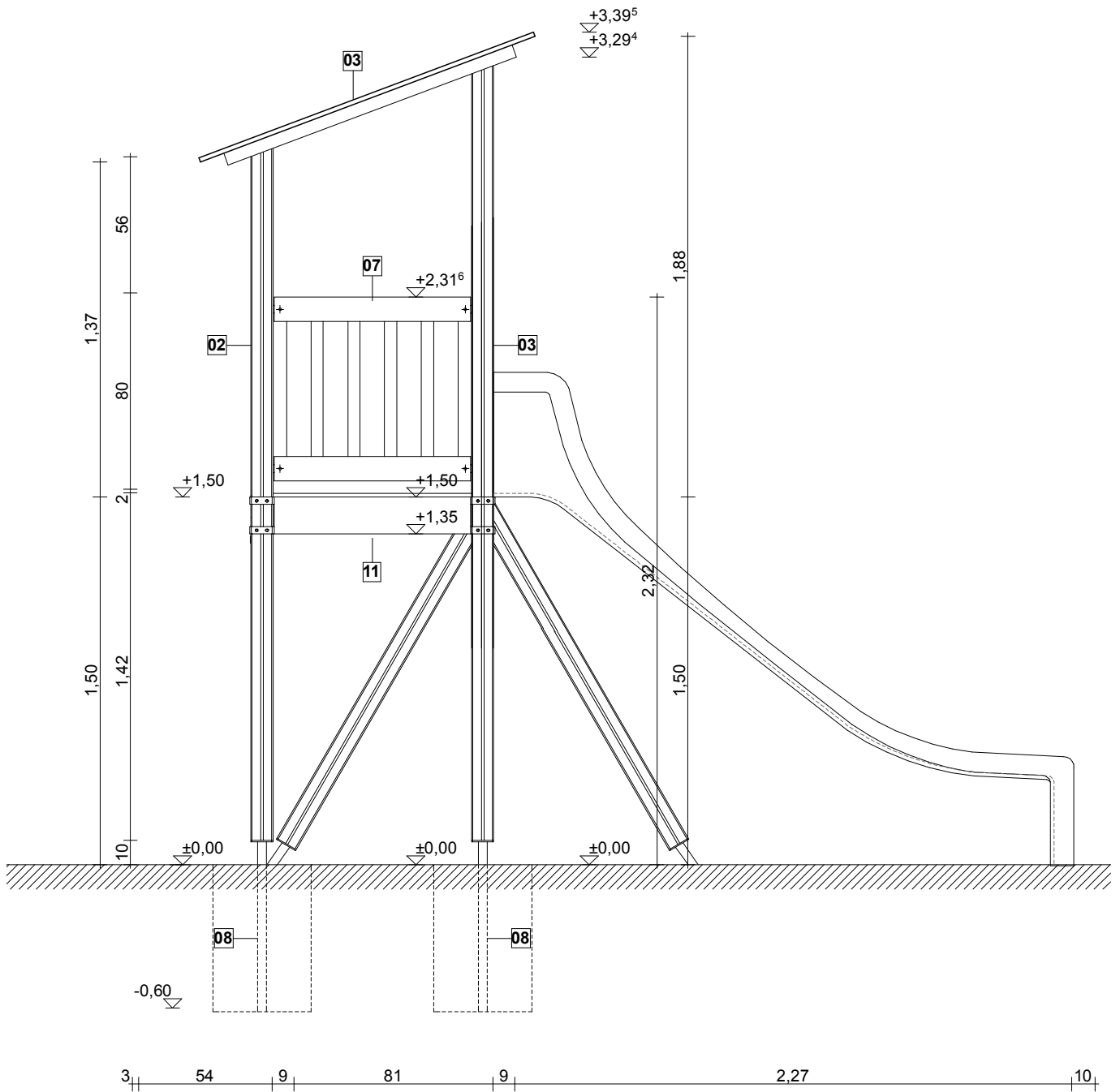

oldalnézet  
m1:25

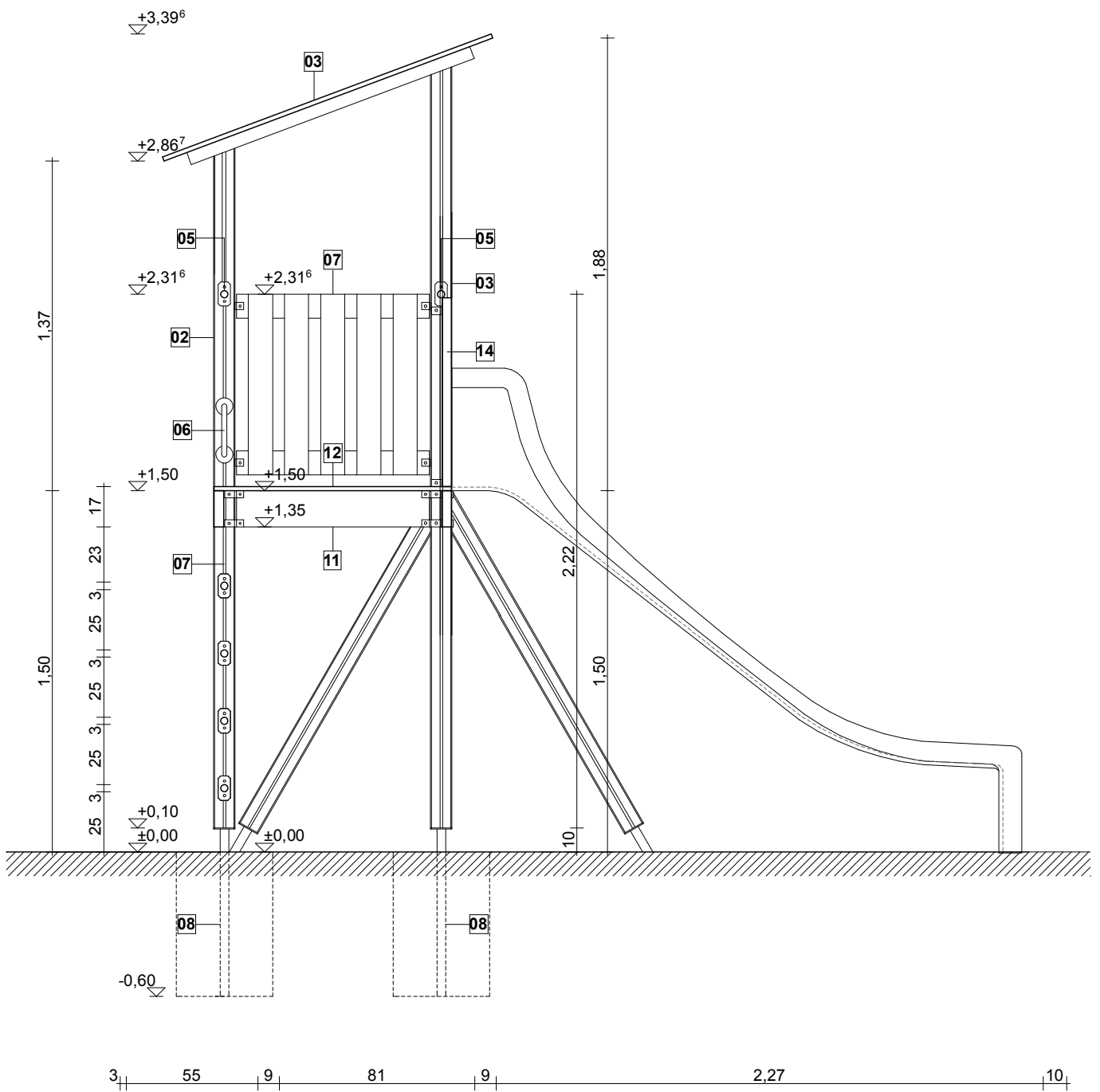

**metszet  
m1:25**

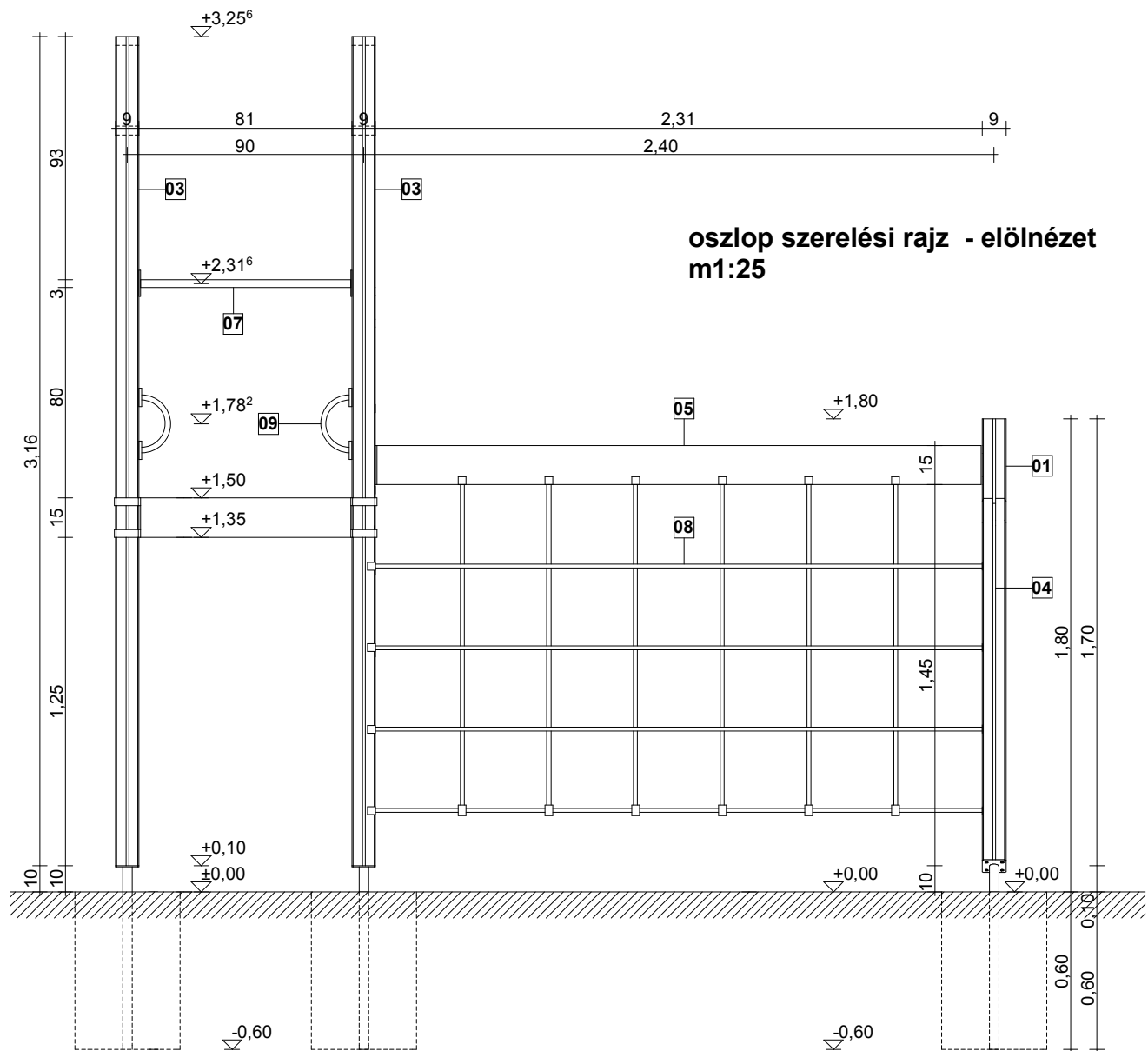

oszlop szerelési rajz - előlnézet  
m1:25

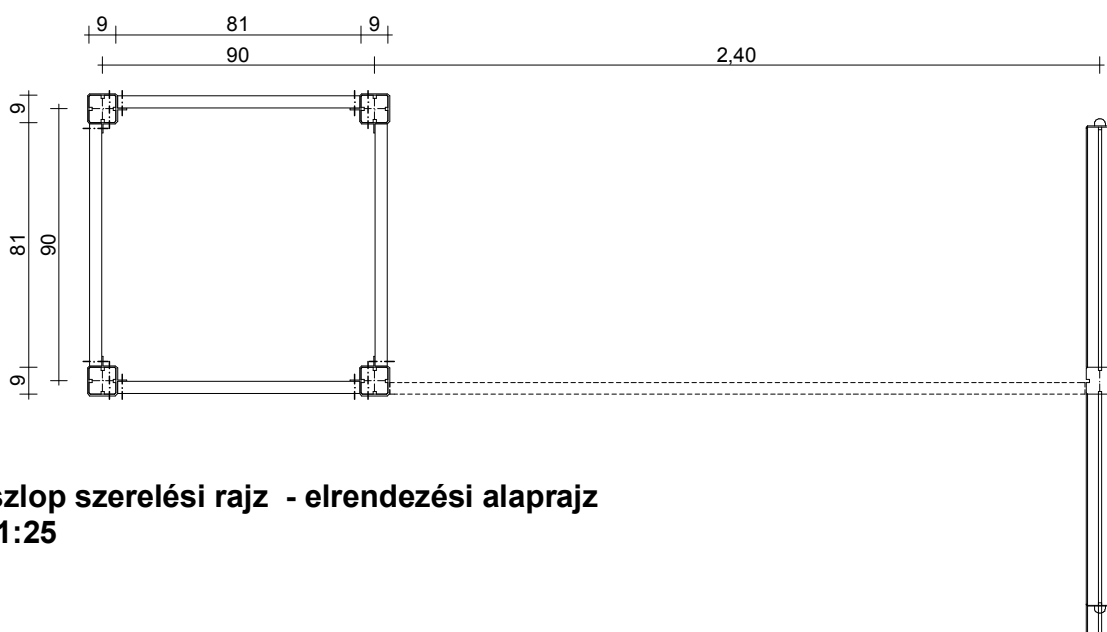

oszlop szerelési rajz - elrendezési alaprajz  
m1:25



oszlop szerelési rajz - 01\_01 jelű metszet  
m1:25

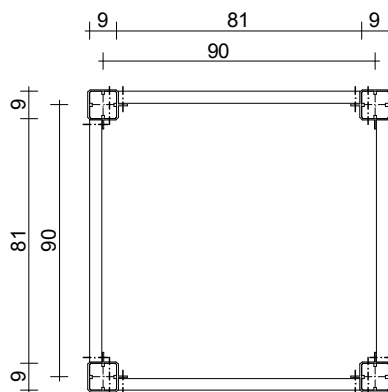
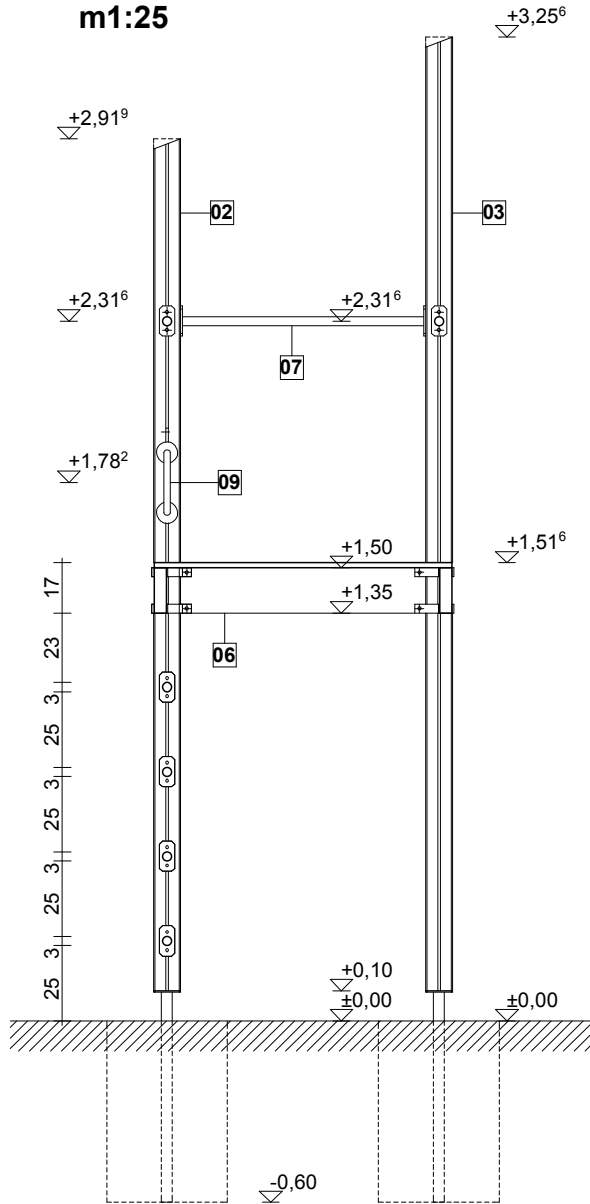

oszlop szerelési rajz - elrendezési alaprajz  
m1:25

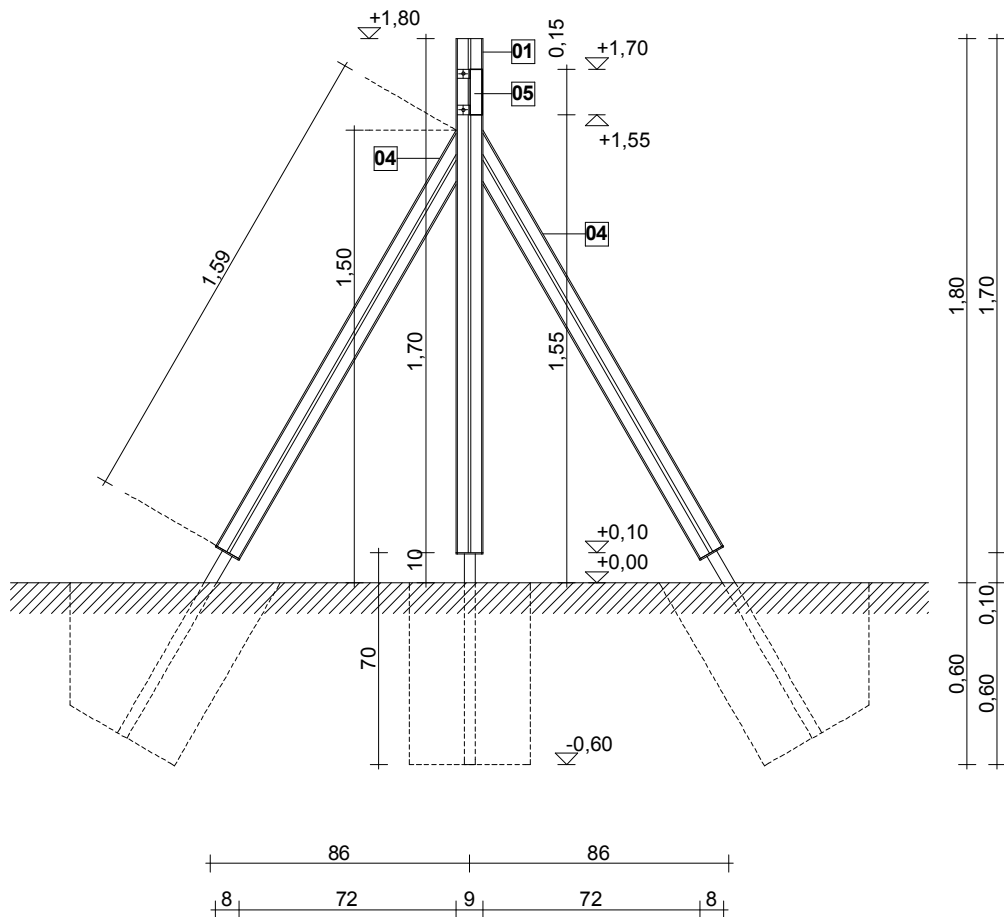

oszlop szerelési rajz - 02\_02 jelű metszet  
m1:25

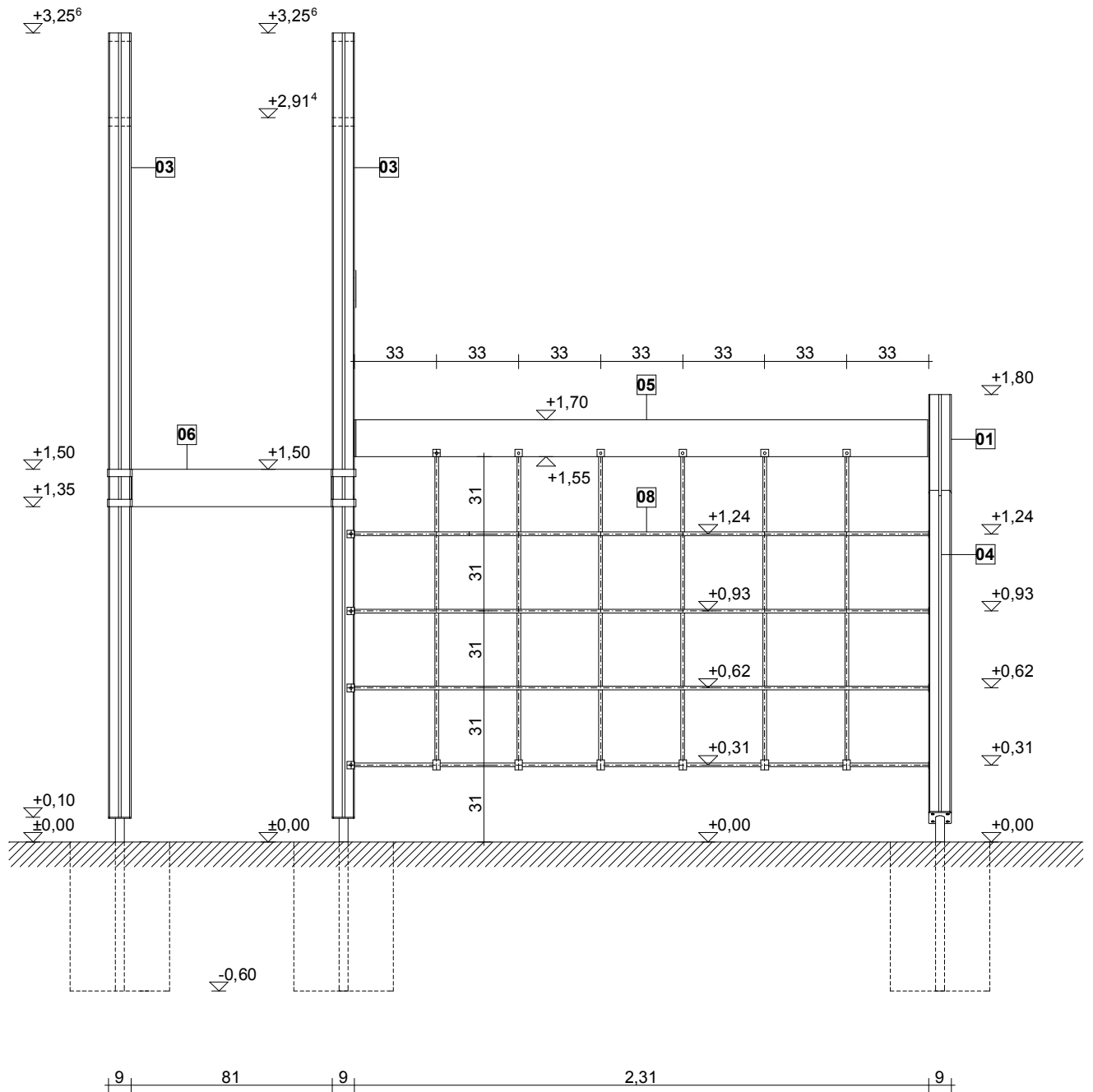

**háló szerelési rajz - előlnézet**  
**m1:25**

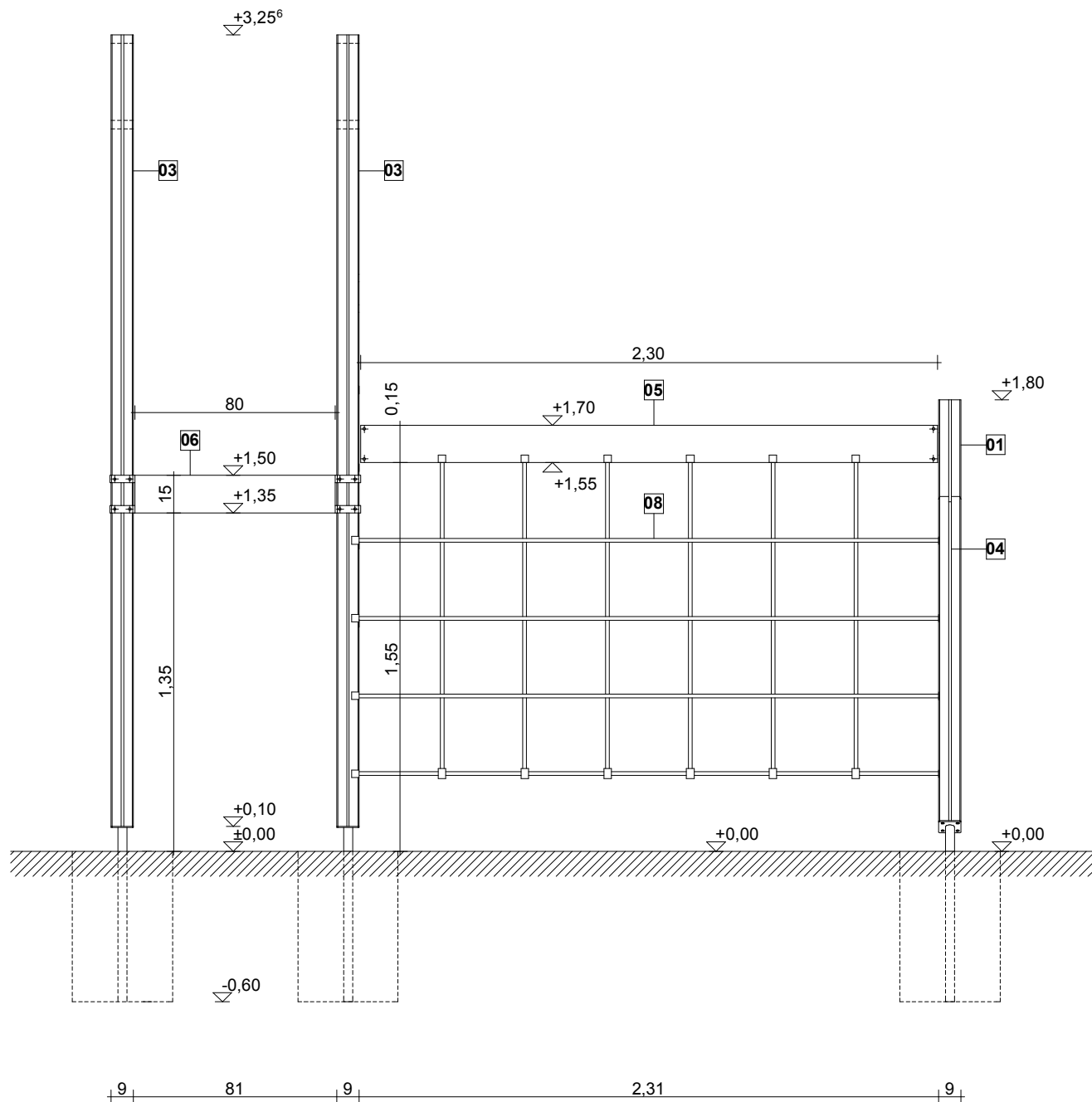

**palló szerelési rajz - előlnézet**  
**m1:25**

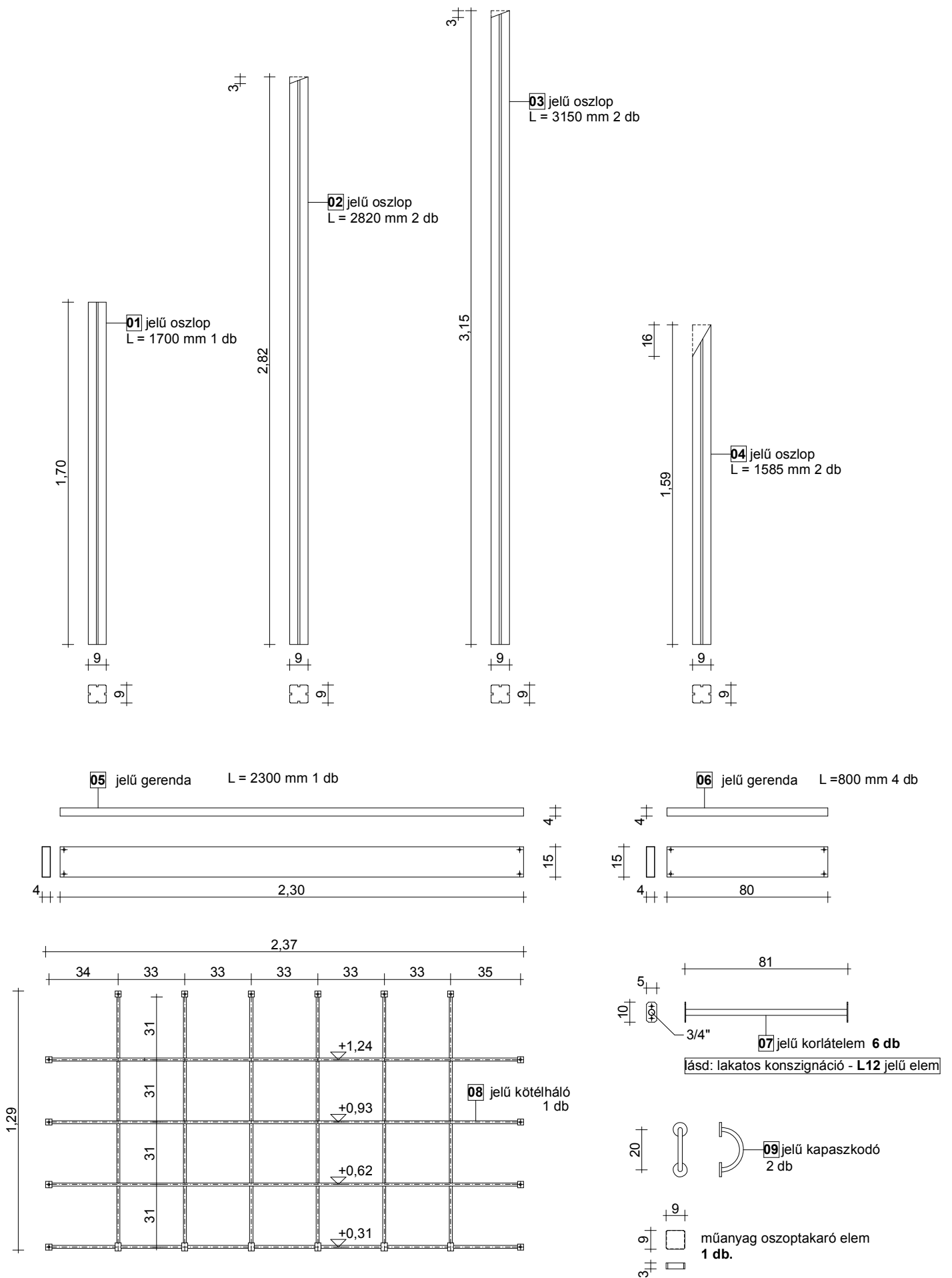

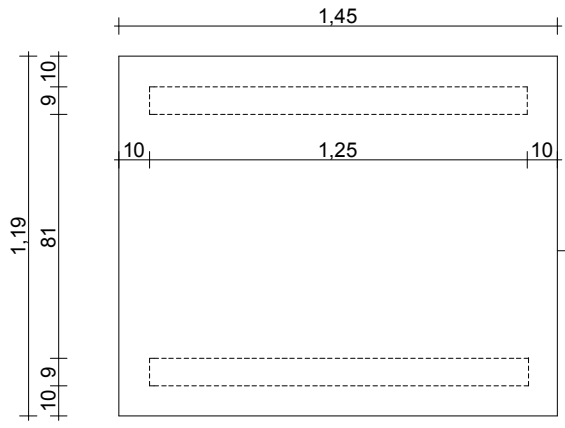

**10** jelű tetőelem  
1450 x 1190 mm v=1,6 mm 1 db

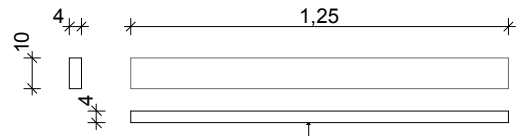

4/10 cm lécs  
hossz: 125 mm - **2db**

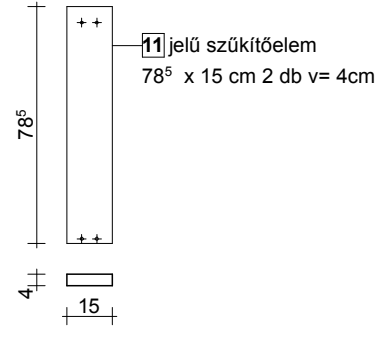
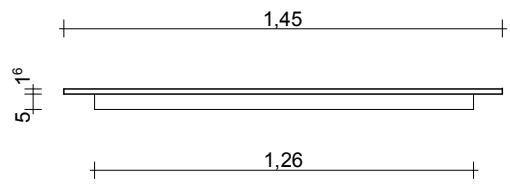

**11** jelű szűkítőelem  
78<sup>5</sup> x 15 cm 2 db v= 4cm

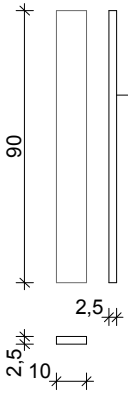

**12** jelű 2<sup>5</sup>/10 deszka  
hossz: 900 mm - **10db**

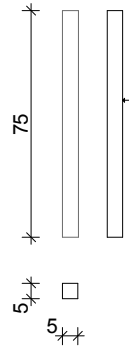

5/5 cm lécs  
hossz: 750 mm - **4db**

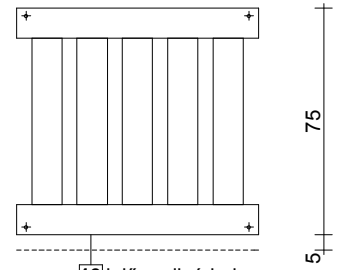
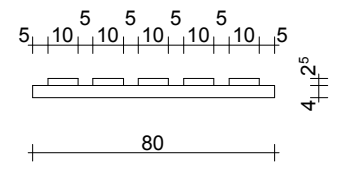

**13** jelű mellvéd elem  
80 x 75 cm **2 db**

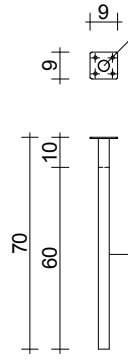

lásd: lakatos konzignáció  
**L04** jelű elem

**14** jelű alapozás  
7 db

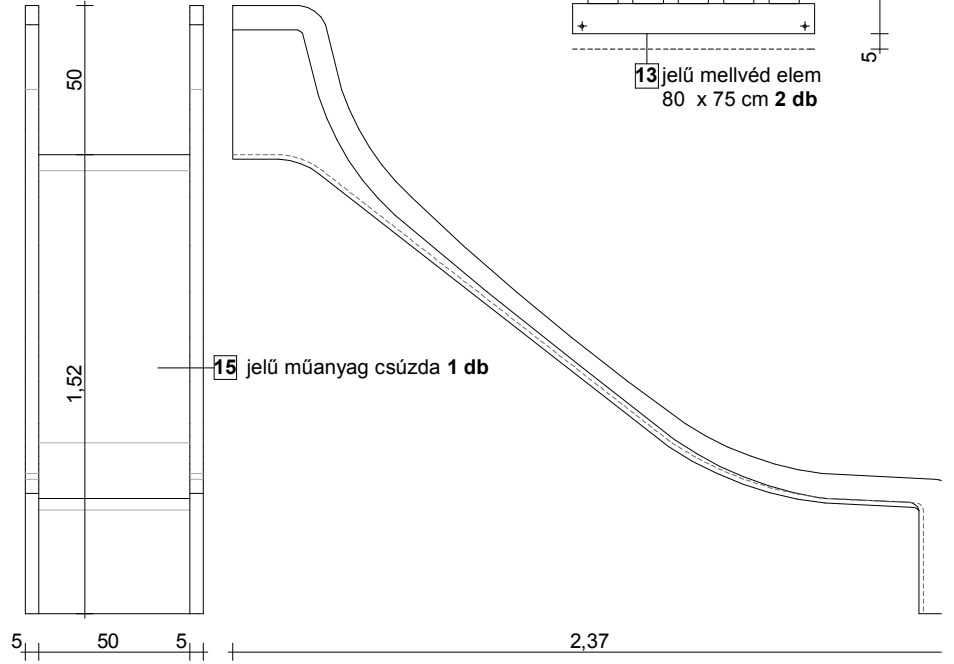

**15** jelű műanyag csúzda **1 db**

**L-01** jelű kapcsolóelem - **8db**

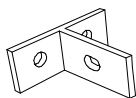

**L-02** jelű kapcsolóelem - **8db**

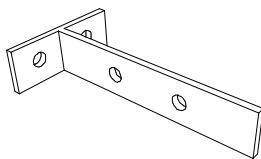

**L-03/1** jelű kapcsolóelem - **16db**

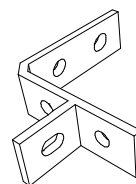

- oszloptakaró sapka: **1 db**