

**Evin Tech Kft.**

eszköz megnevezése:  
**láncos lengőhinta**

**cikkszám: LLH-04**  
dátum: 2016 04.25.

**metszet m1:25**

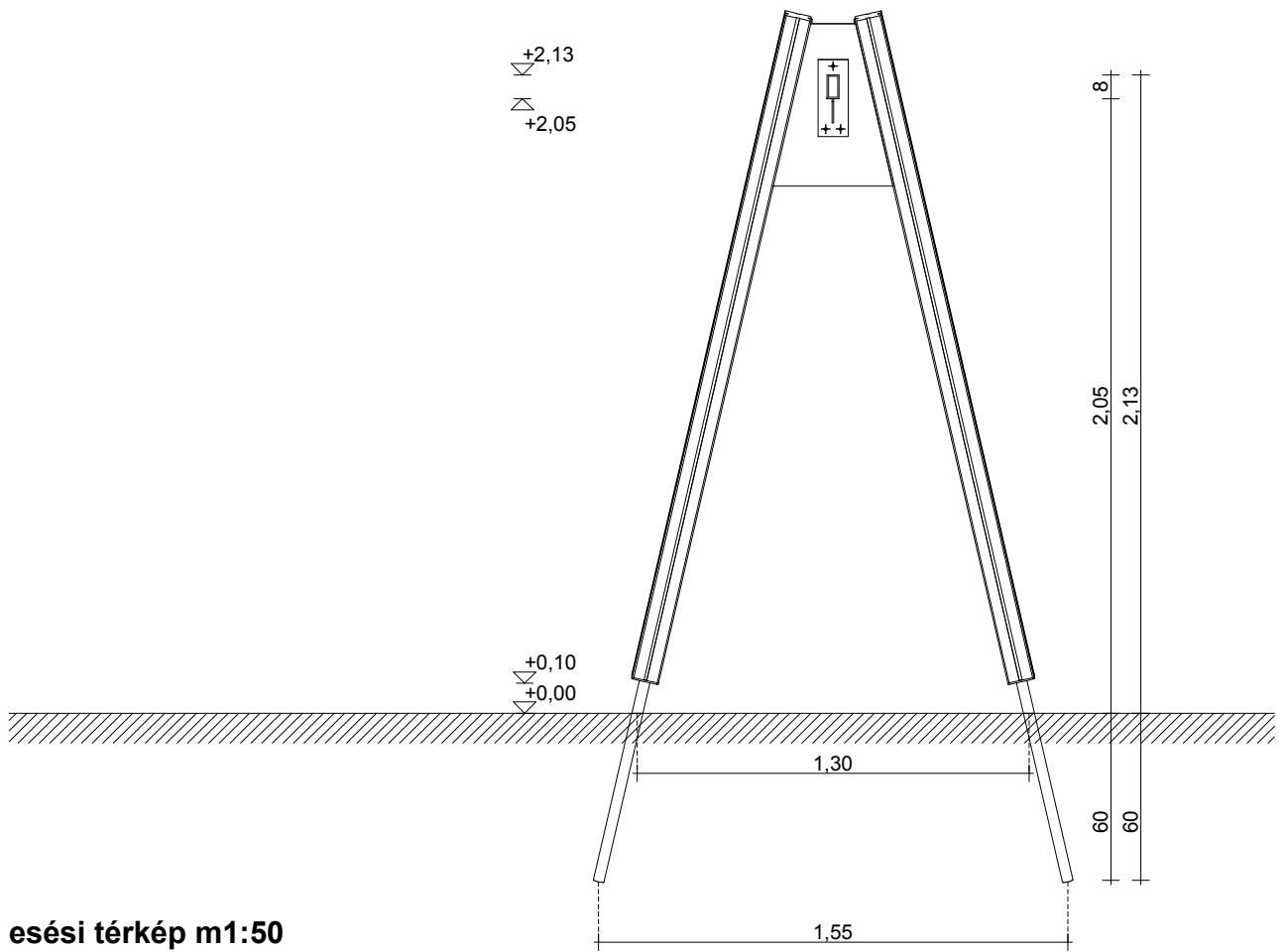

**esési térkép m1:50**

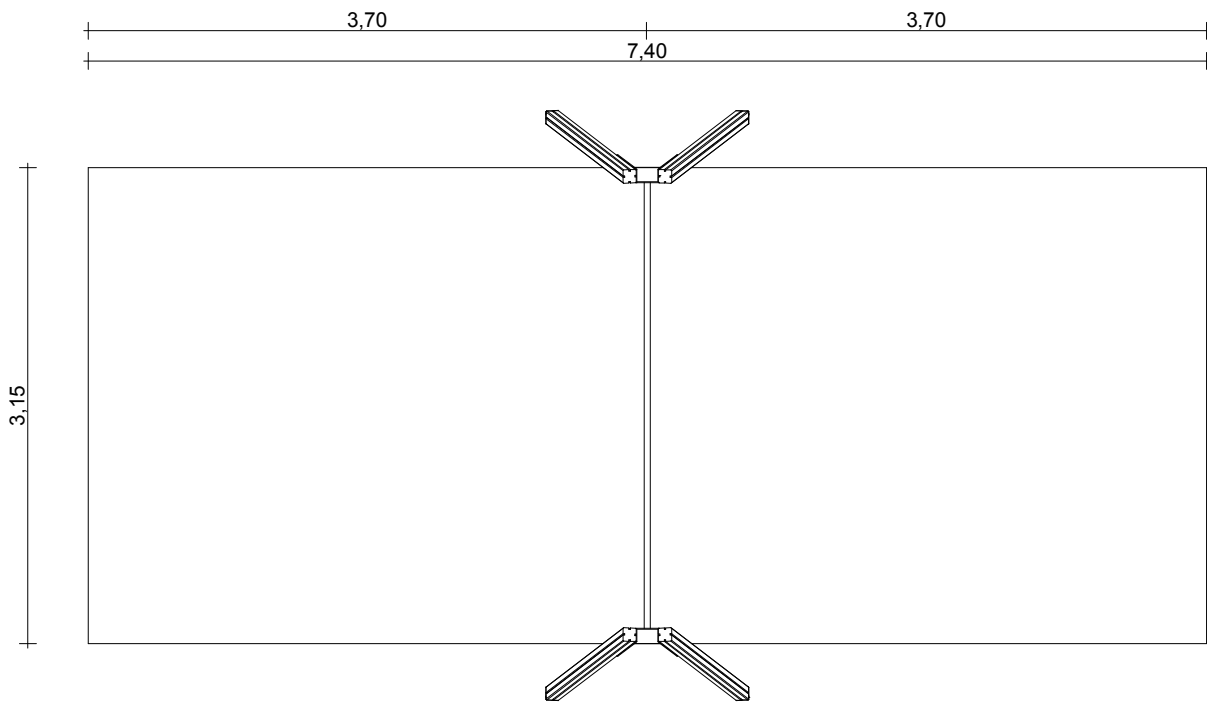

előlnézet m1:25

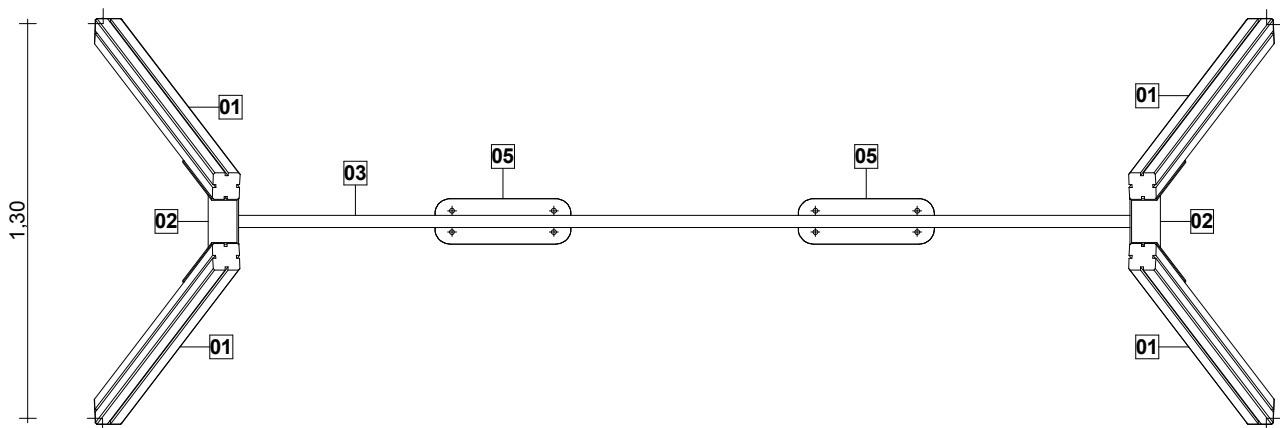
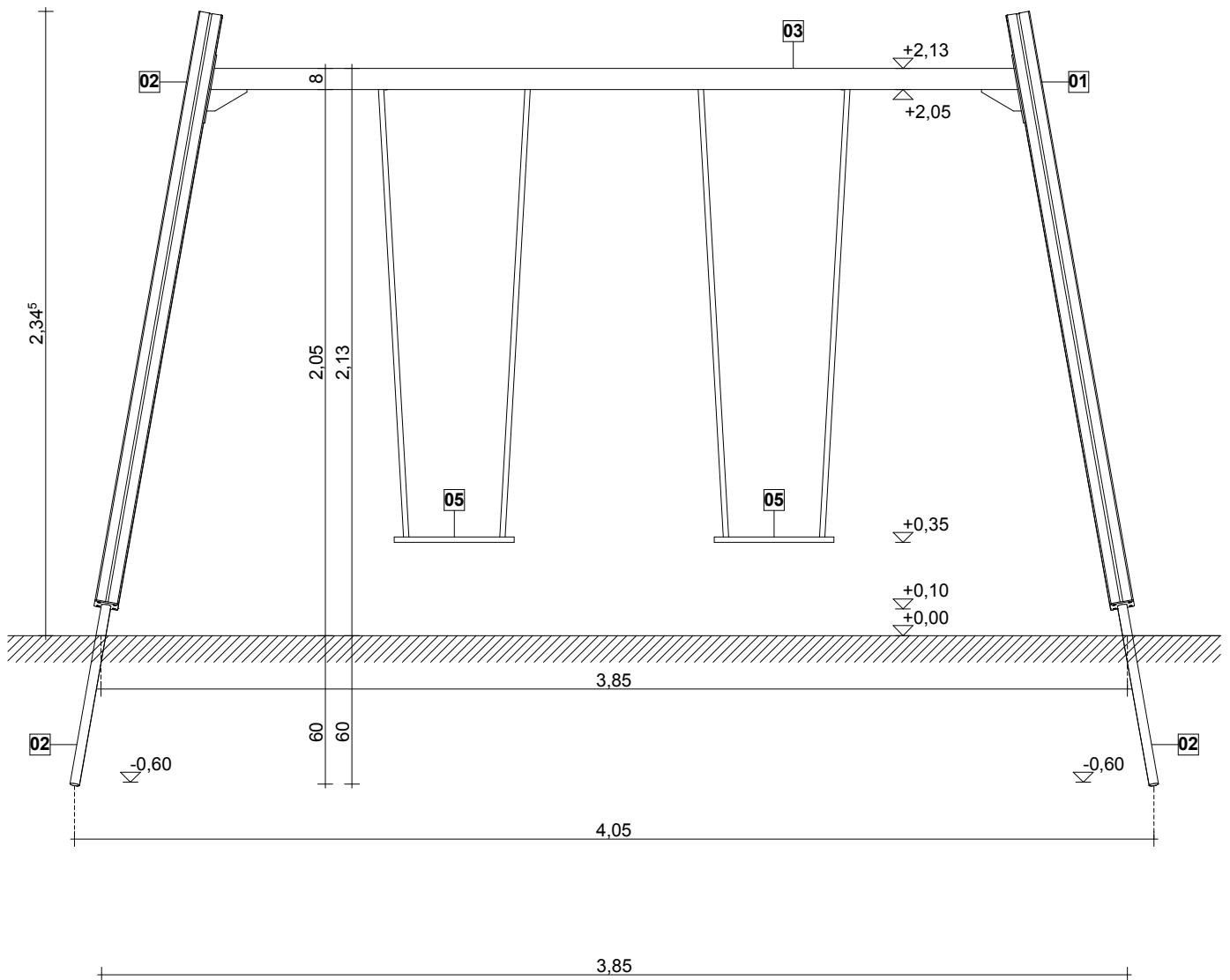

alaprész m1:25

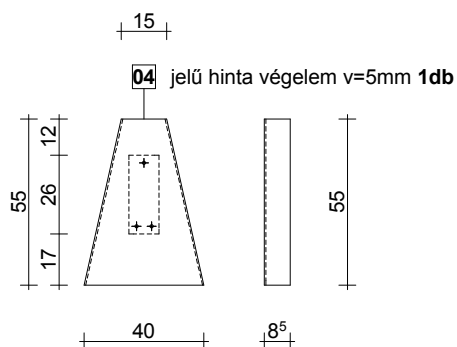
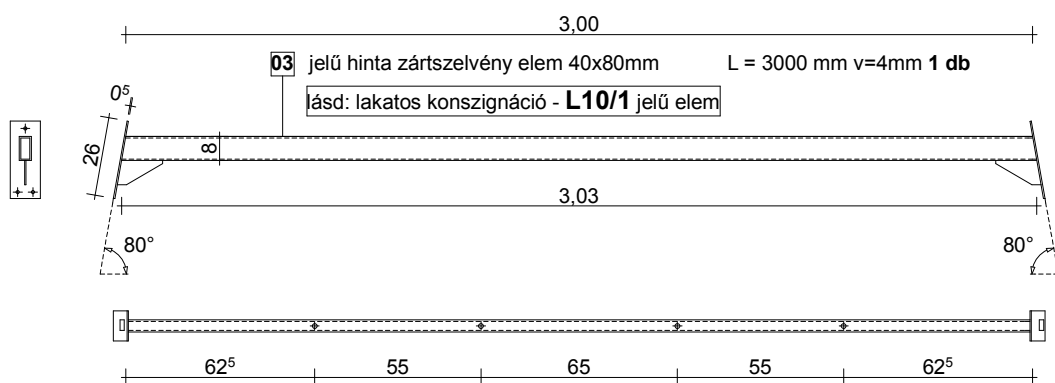
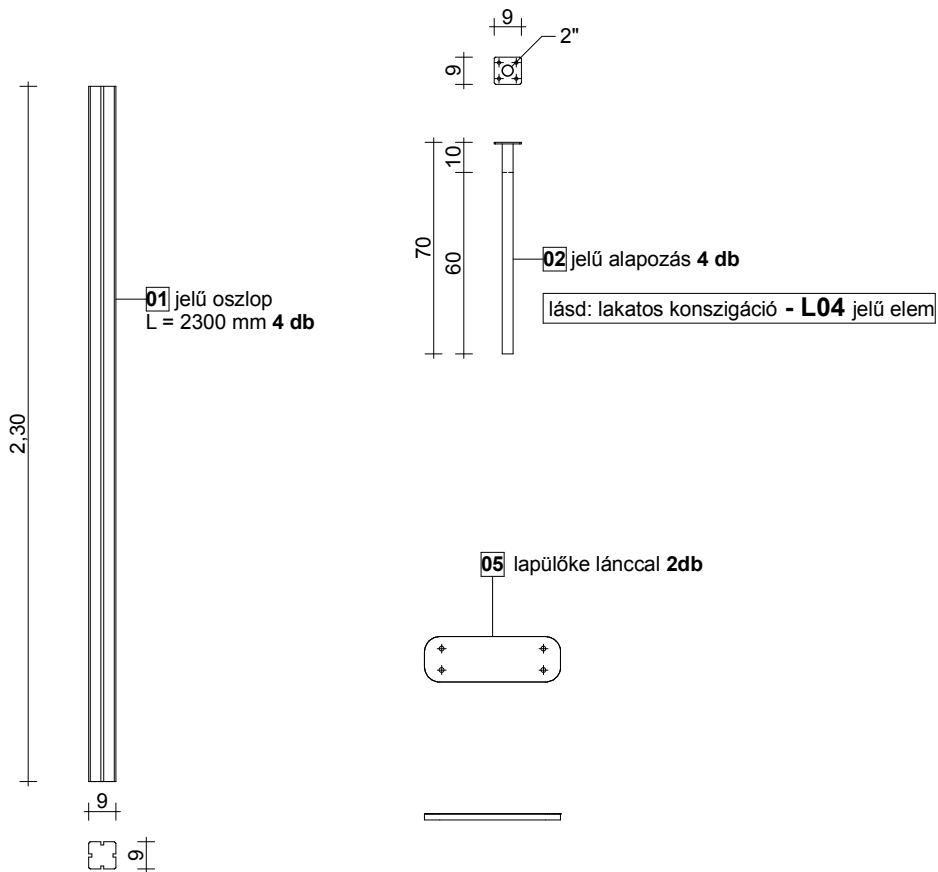

- oszloptakaró sapka: 4 db
- csavartakaró gomb: 30 db
- hintacsukló: 4 db